

12:1 'Direct Box' Transformer

DUAL FARADAY SHIELDS FOR HIGH ISOLATION

- Converts unbalanced line levels to balanced mic level output
- Stops 'hum and buzz' problems in musical instrument hook-ups
- Allows use of long cables without high frequency loss
- High common-mode rejection: 100 dB at 60 Hz
- Excellent frequency response and time domain performance

When loaded by the 1 kΩ input impedance typical of mic preamplifiers, this transformer has a 140 kΩ input impedance, making it ideal for high impedance sources. It can be used with or without an active buffer as a 'direct box' for electric guitars or synthesizers. A 30 dB magnetic shield package is standard.

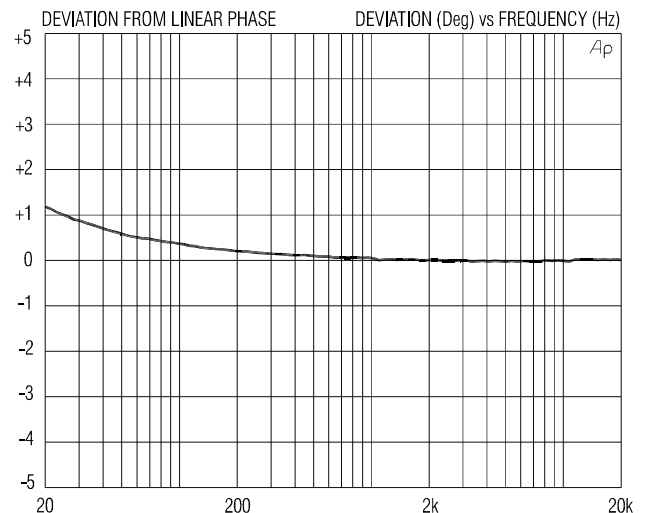
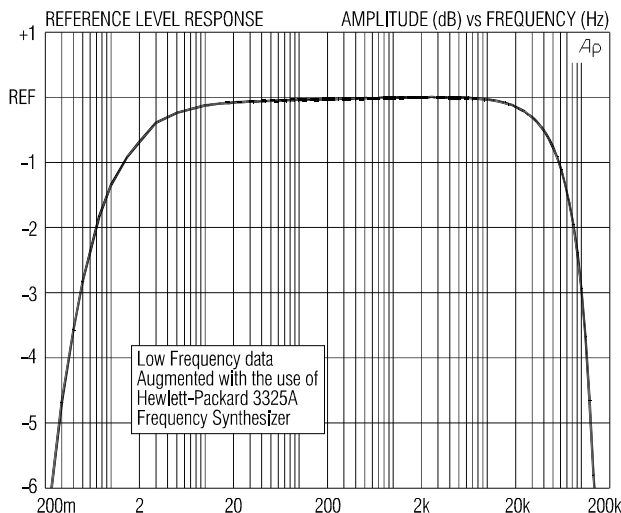
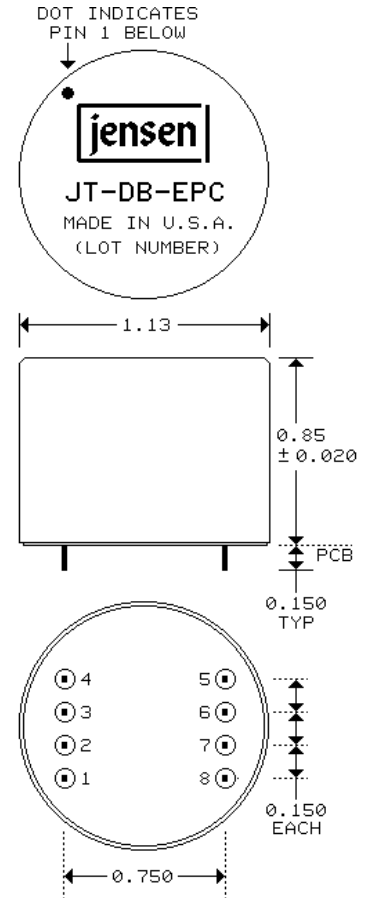
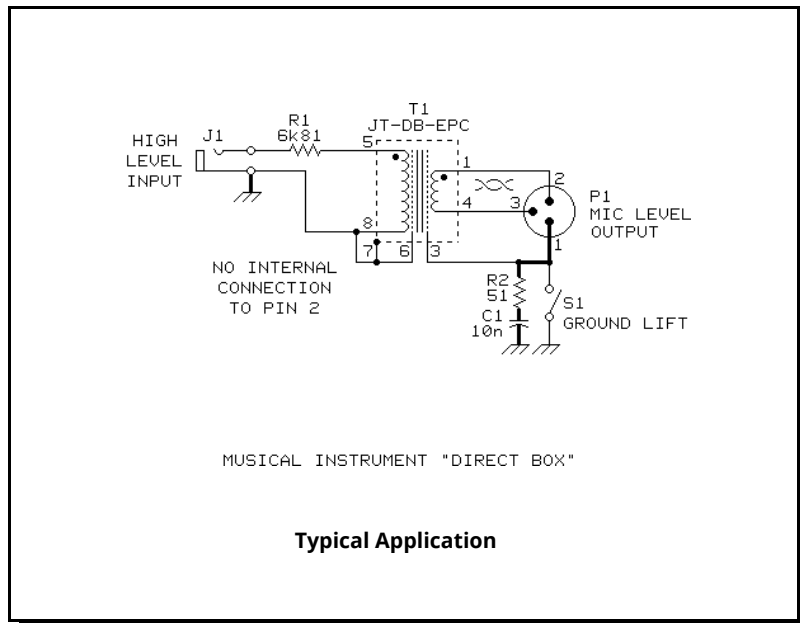

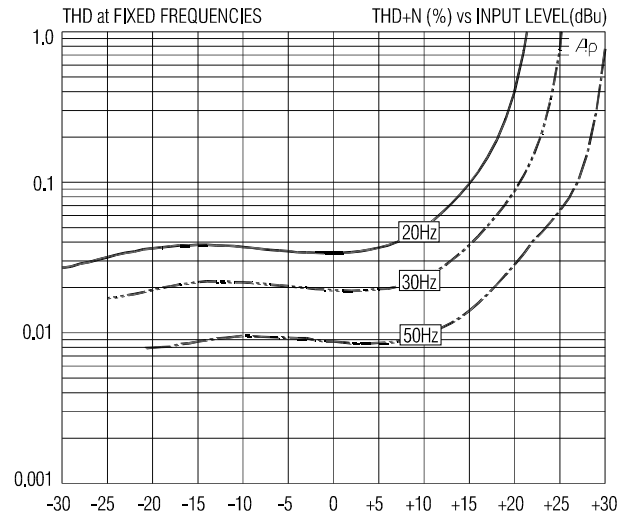
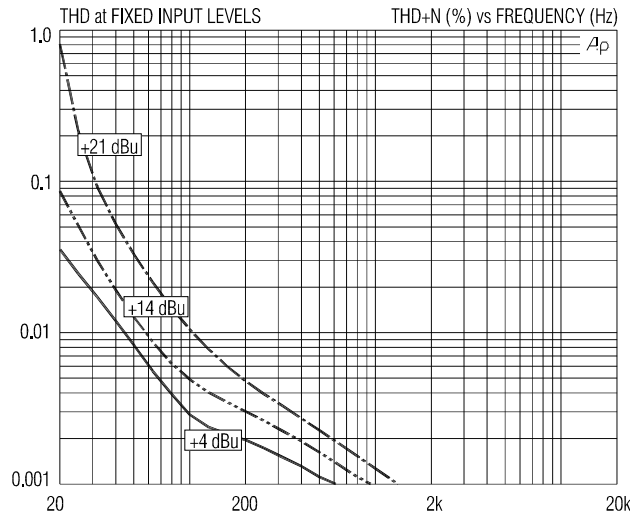

JT-DB-EPC SPECIFICATIONS (all levels are input unless noted)

PARAMETER	CONDITIONS	MINIMUM	TYPICAL	MAXIMUM
Input impedance, Zi	1 kHz, 0 dBu, test circuit 1	130 kΩ	141 kΩ	150 kΩ
Voltage gain	1 kHz, 0 dBu, test circuit 1	-22.2 dB	-22.0 dB	-21.8 dB
Magnitude response, ref 1 kHz	20 Hz, +4 dBu, test circuit 1	-0.25 dB	-0.08 dB	0.0 dB
	20 kHz, +4 dBu, test circuit 1	-0.25 dB	-0.07 dB	+0.1 dB
Deviation from linear phase (DLP)	20 Hz to 20 kHz, +4 dBu, test circuit 1		+1.2/-0°	±2.0°
Distortion (THD)	1 kHz, +4 dBu, test circuit 1		<0.001%	
	20 Hz, +4 dBu, test circuit 1		0.036%	0.10%
Maximum 20 Hz input level	1% THD, test circuit 1	+19.5 dBu	+21.5 dBu	
Common-mode rejection ratio (CMRR) unbalanced source	60 Hz, test circuit 2		100 dB	
	3 kHz, test circuit 2	55 dB	65 dB	
Output impedance, Zo	1 kHz, test circuit 1	145 Ω	150 Ω	155 Ω
DC resistances	primary (pin 5 to pin 8)		4.6 kΩ	
	secondary (pin 1 to pin 4)		62 Ω	
Capacitances @ 1 kHz	primary to shield and case		60 pF	
	secondary to shield and case		115 pF	
Turns ratio		11.51:1	11.52:1	11.53:1
Temperature range	operation or storage	0° C		70° C
Breakdown voltage (see IMPORTANT NOTE below)	primary or secondary to shield and case, 60 Hz, 1 minute test duration	250 V RMS		

IMPORTANT NOTE: This device is NOT intended for use in life support systems or any application where its failure could cause injury or death. The breakdown voltage specification is intended to insure integrity of internal insulation systems; continuous operation at these voltages is NOT recommended. Consult our applications engineering department if you have special requirements.

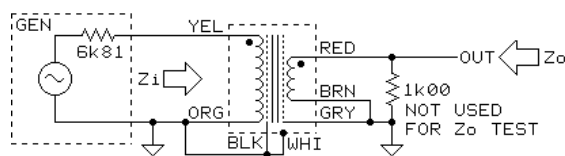

TEST CIRCUIT 1

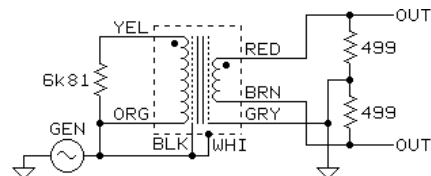

TEST CIRCUIT 2

All minimum and maximum specifications are guaranteed. Unless noted otherwise, all specifications apply at 25°C. Specifications subject to change without notice. All information herein is believed to be accurate and reliable, however no responsibility is assumed for its use nor for any infringements of patents which may result from its use. No license is granted by implication or otherwise under any patent or patent rights of Jensen Transformers, Inc.